

FINISHES:

MAIN STRUCTURE: STAINLESS STEEL
 FOOD SAFE POWDER COATED BLACK (RAL 9005)
 ALTERNATIVE RAL COLOUR OPTION (DCOL2)
 END GLASS: 6m CLEAR TOUGHENED
 WIRE GRIDS: 304 GRADE STAINLESS STEEL

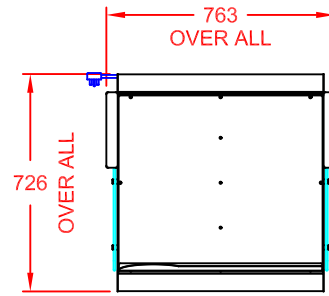

PLAN VIEW

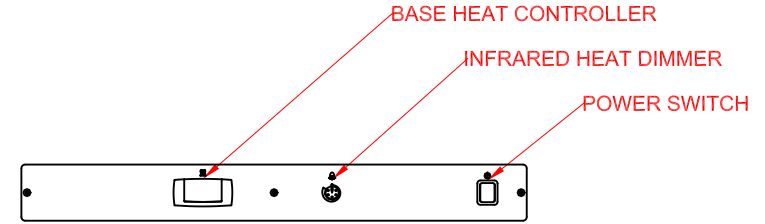

CONTROL PANEL DETAIL

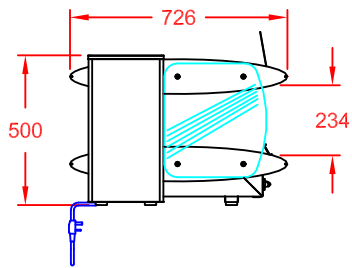

END VIEW

BRANDING HEADER
 GRAPHICS MOUNTING PANEL
 OPTION (DBH2)
 & VINYL GRAPHIC LABEL
 OPTION (DVG2)
 (NOTE: MOQ 10 UNITS)

5 x REMOVABLE
 SHELF DIVIDERS

13A PLUG TOP
 & 2m LEAD
 POWER SUPPLY:
 13A, 230V, 1.33kW

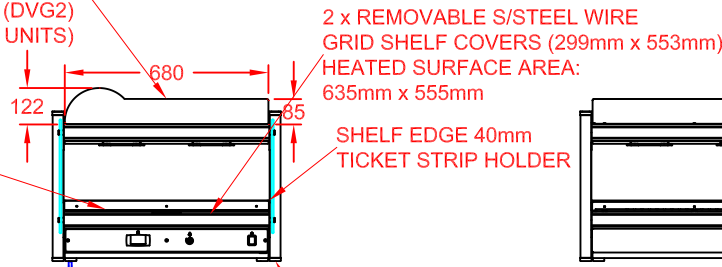

FRONT VIEW
 (CUSTOMER SIDE)

2 x REMOVABLE S/STEEL WIRE
 GRID SHELF COVERS (299mm x 553mm)
 HEATED SURFACE AREA:
 635mm x 555mm

SHELF EDGE 40mm
 TICKET STRIP HOLDER

RUBBER FEET

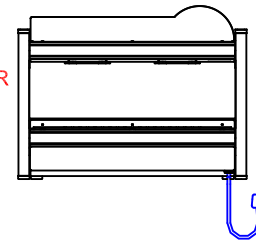

REAR VIEW
 (OPERATOR SIDE)

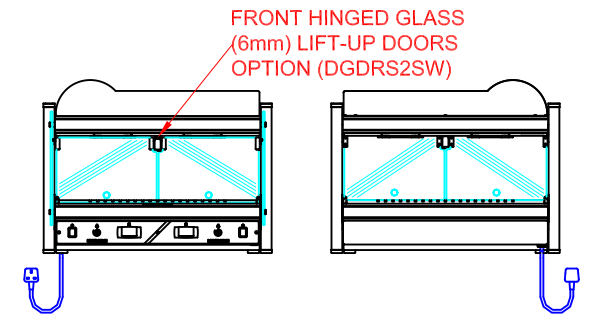

FRONT VIEW
 (CUSTOMER SIDE)
 c/w FRONT DOOR OPTION

REAR VIEW
 (OPERATOR SIDE)
 c/w FRONT DOOR OPTION

APPROX. UN-CRATED
 WEIGHT OF UNIT: 31Kg



CED FABRICATIONS LTD
 UNITS A1-A4, FALCON COURT
 CLAYTON BUSINESS PARK
 CLAYTON-LE-MOORS
 HYNDBURN
 LANCASHIRE BB5 5JD

This drawing and information herein is confidential to CED Fabrications Ltd. It is issued in confidence that it will not be disclosed to any third party in part or in whole without permission from CED FABRICATIONS Ltd.

© CED FABRICATIONS LTD

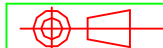

DESCRIPTION:

DESIGNLINE SINGLE TIER
 2-1 G_n TABLE TOP HEATED
 MERCHANDISER (STRAIGHT SHELVING)
 WALL SITED c/w ALL OPTIONS

SCALE: 1 : 2.5 @ A4 REV No:

PRODUCT CODE: DTTMS2SW