

SELF HELP CHILLED PATISSERIE (REAR DOORS) - FITTING INSTRUCTIONS

MODELS:
PC6,9,12,20HT

R290 REFRIGERANT

General Installation Considerations

- 1) Area in which display is to be sited must have a minimum room volume no less than 95 cu m (PC6HT), 109 cu m (PC9HT), 122 cu m (PC12HT) or 132 cu m (PC20HT).
- 2) Install over a sealed floor or ventilated floor void.
- 3) Do not site the display within 2m of ceiling mounted air conditioning grilles.
- 4) Do not site the display beneath a high level of direct sunlight.
- 5) Display will operate in a 24 hour environment.
- 6) Access to maintain condensing unit should be made via removable fascia panels or doors to customer and operator side of counter.

FREE-STANDING APPLICATION

A) ROLL UNIT INTO POSITION

UNIT SUPPLIED WITH CASTORS

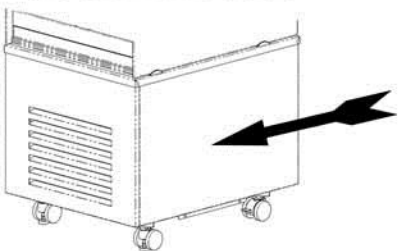

B) ADJUST UNIT HEIGHT

USING SUPPLIED SPANNER

(ENSURE THE HALF NUT IS WOUND FULLY UPWARDS)

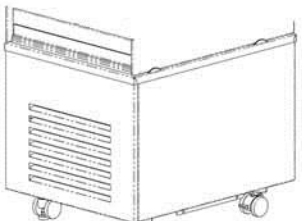

C) FIT KICK PLINTH

FRONT & REAR LOCATES WITH MAGNETS

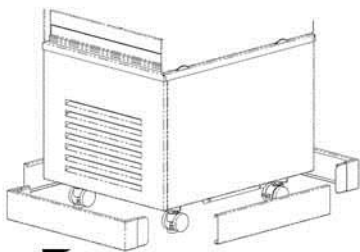

NOTE: KICKPLINTH SUPPLIED AS STANDARD IS SUITABLE FOR LOWEST ADJUSTED UNIT HEIGHT

COUNTER LOCATED APPLICATION

FLUSH FITTING FASCIA PANEL

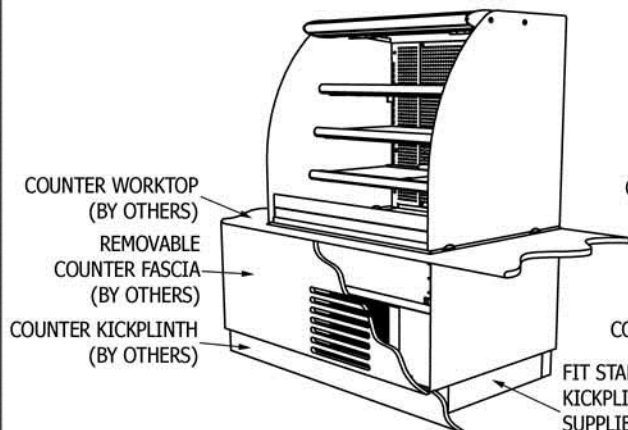

COUNTER WORKTOP (BY OTHERS)
REMOVABLE COUNTER FASCIA (BY OTHERS)
COUNTER KICKPLINTH (BY OTHERS)

FIT STANDARD KICKPLINTH SUPPLIED (IF REQUIRED)

STAND-OFF FASCIA PANEL

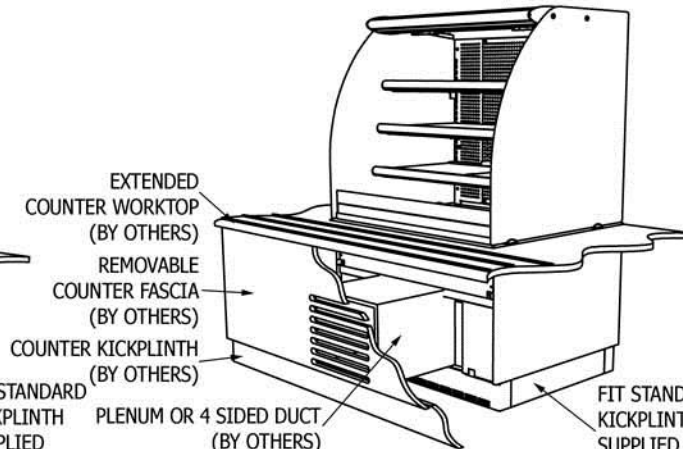

EXTENDED COUNTER WORKTOP (BY OTHERS)
REMOVABLE COUNTER FASCIA (BY OTHERS)
COUNTER KICKPLINTH (BY OTHERS)

FIT STANDARD KICKPLINTH SUPPLIED (IF REQUIRED)

A PLENUM OR 4 SIDED TUNNEL (MADE FROM MDF, PLYWOOD OR NILFLAM TYPE MATERIAL) MUST BE FITTED BETWEEN THE REAR FACE OF THE CUSTOMER SIDE FASCIA PANEL AND THE FRONT FACE OF THE COMPRESSOR CRADLE, AROUND THE AIR INTAKE CUT-OUT, TO STOP THE RE-CIRCULATION OF HOT AIR FROM THE COMPRESSOR. SILICON SEAL AROUND EDGES TO ENSURE THERE ARE NO AIR GAPS.

FITTING SHELVES

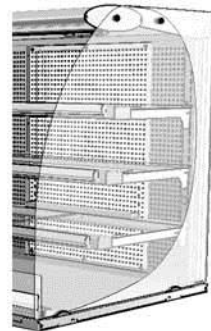

LOCATE SHELF SUPPORT BRACKETS INTO REAR SLOTS AT HEIGHT & ANGLE TO SUIT PRODUCTS (NOTE: SHORTEST BRACKETS AT TOP AND LONGEST BRACKETS AT BTM). REST GLASS SHELVES ONTO RUBBER BUMPERS ON SHELF SUPPORTS. (NOTE HALF-LENGTH SHELVES ARE LOCATED ON BOTTOM TO ALLOW FOR TALLER BOTTLES ON DECK)

CUT-OUT LOCATION FOR AIR GRILLE (CUSTOMER SIDE FASCIA PANEL)

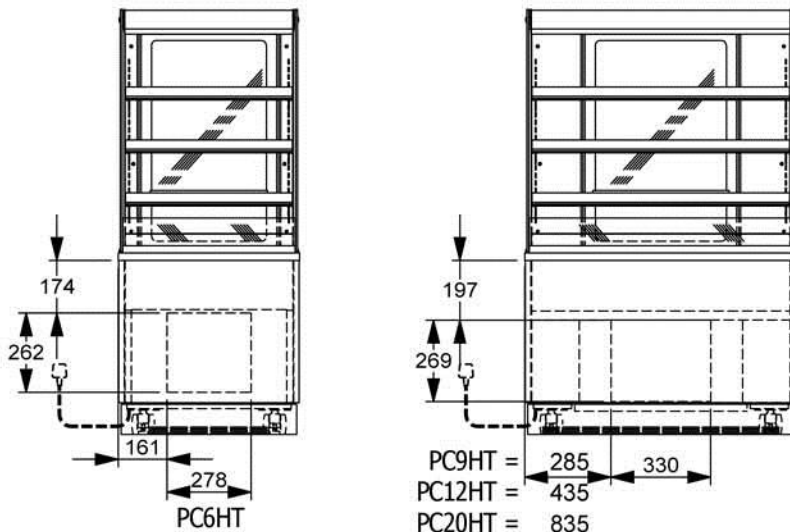

FASCIA PANEL CUT-OUT DETAIL

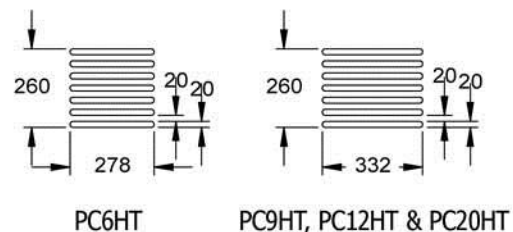

Tel. 01254 238 282 Fax. 01254 238 228
e-mail: aftersales@cedlimited.com