



## FEATURES

### Model Size.

The DTTHMS2W wall sited hot merchandiser is an open fronted hot display 763mm wide.

### 2 Zone Storage Capacity: 2 Tier Hot Shelving With Overhead Heating.

The display features 2 no. horizontal heated shelves, each with overhead jacketed infrared top heat lamps. Both upper & lower zones are independently controlled, have removable wire steel shelf grid covers for use with packaged & cartoned heated produce. The display area is finished in food safe polyester coated steel. Removable steel bars allow food to be stored in rows. A 40mm (H) ticket strip mount is provided to each shelf front.

### Energy Saving Facility.

For certain less busy serving periods, upper or lower zones can be independently switched off to conserve energy use.

### Model Type: (Wall Sited) Self Help Hot Merchandiser (Open Rear).

Open fronted display for either short term food set down or grab n' go. Re-stocking access is by the open front. The temperature of each heated zone can be independently set using it's own digital display & infrared top heat regulator, mounted in the front of the base.

### Panoramic Glass Sides.

Side glass panels provide panoramic product display, offer environmental side draught protection & allow natural lighting.

### Model Dimensions.

763mm (L) x 726mm (D) x 792mm (H).

### Recessed Shelf Dimensions.

635mm (L) x 555mm (D) x 230mm (H). A 40mm (H) ticket strip is fitted to each shelf.

### System Design.

Static heating maintains food core, whilst variable jacketed, overhead infrared top heat lamps surround the food surface. Stainless steel wire grid covers allow heat circulation around packaged food types. Removable steel bar dividers allow food to be stored in rows.

### Temperature Performance.

Factory set for 70 - 75°C (+18°C ambient), each display zone temperature is adjustable.

### Temperature Controls.

Each heated zone can be independently set using it's own digital display (base heat) & infrared regulator (top heat), mounted in the front base (customer side). Mains power to each zone is controlled by separate neon on/off switch.

### Finishes.

430gd food safe polyester coated s/steel in black (Ral 9005). Toughened glass side screen panels. 2x removable stainless steel wire shelf grid covers per zone (each 553 x 299mm).

### Power Supply.

Supplied with 2m lead & 13 amp UK plug (13A 230V 50Hz) 2.85 kW.

### Low Maintenance.

Easy, cleanable surfaces and a durable design ensure low maintenance for users.

### Equipment Conformity.

CE & UKCA Certified equipment.

## ABOUT

This energy efficient, wall sited hot merchandiser is factory pre-set at 75°C & offers customers two horizontal tiers of independently controlled grab n' go hot food holding, within a minimal 763mm (w) x 726mm (d) x 792mm (h) footprint. The front facing controls allow wall sited use.

This 13A heated self help s/steel display is finished in a signature food safe black coating & is ideal for the display of pre-heated cooked food, packaged, cartoned or unwrapped heated product. The table top heated merchandiser features digitally controlled static shelf heating to maintain food core, whilst variable, jacketed infrared top heat surrounds the food surface. Removable s/ steel wire grid shelf covers allow heat circulation around packaged food types. Removable steel bar dividers, also included allow food to be stored in rows.

Panoramic product display is provided through glazed side panels which also offer environmental side draught protection. The temperature of each heated zone can be independently set using its' own digital display & infrared top heat regulator, each mounted in the front customer side base. Product temperature is maintained at 70 - 75°C in +18°C ambient. In quieter serving periods, upper or lower zones can be independently switched off to conserve energy use. A branded header panel with vinyl transfer can be provided.

This open faced, front loading merchandiser operates with a max. 2.85 kW power supply when both zones are operating. It is ergonomically designed with 'touch safe' extruded aluminum shelf and canopy edges to allow serve through or grab n' go use at counter top height. The merchandiser can be used either wall sited or front of house as a short term food set down point, or a hot holding area for wrapped/ unwrapped pre-heated goods. The unit is stabilised with rubber feet and features a 2m lead and UK 13A plug top (230v 50 Hz). A 40mm (H) ticket strip mount is available to each shelf front.

## FOOD TYPES

### Food (Shelving Area):

Packaged or unwrapped fries, pies, pastries, noodles, rice, sausage rolls, hot dogs, stews, curry, chilli dishes, grilled sandwiches, hot baguettes, hot ciabatta, pasta in sauce, ribs with sauce, chicken portions, pizza slices.



40mm (H) Ticket Strip Mount

## SPECIFICATION

Code	Description	Dimensions (L x D x H mm)	Weight (kg)	Power Rating (kW)
DTTHMS2W	(Wall Sited) T.Top Hot Merch.	763 x 726 x 792	31	2.85

### Model Description.

(Wall sited) hot table top merchandiser, self help, (2) heated horizontal shelving, (1) canopy head, open front & rear, 763mm W x 726mm D x 792mm H, variable static base heat & overhead jacketed infrared variable heat, (2) independently operated heat zones, digital control panels/ dimmer switches, each zone, controls to front base, (2) polyester coated fixed angle shelves, (4) removable wire steel shelf covers, (10) removable s/steel rod shelf dividers, s/ steel construction finished in food safe polyester coated black (Ral 9005), 40mm (H) ticket strip mount to each shelf, toughened side glass, mounted on rubber feet, CE/UKCA, 2m lead/UK Plug (13A 230V 50 Hz 2.85kW).

## DIMENSIONS

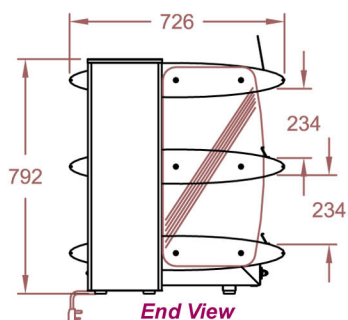

End View

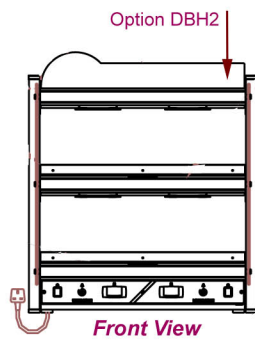

Front View

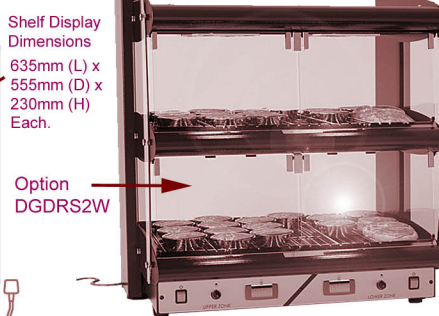
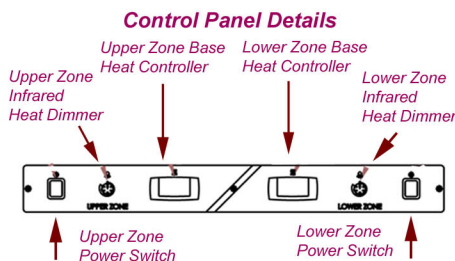

Shelf Display Dimensions  
635mm (L) x 555mm (D) x 230mm (H) Each.

Option DGDRS2W

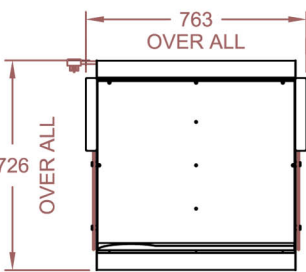

Plan View

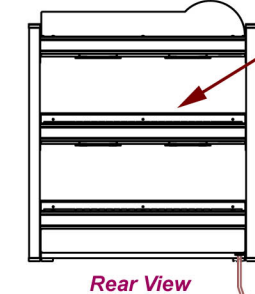

Rear View

## OPTIONS

**(Option DBH2) Graphics Header Panel**  
Brand header graphics mounting panel, 680mm (w) x 122/85mm (h) – powder coated black

**(Option DVG2) Vinyl Graphic Label**  
Vinyl graphic label, 680mm (w) x 122/85mm (h), supplied to artwork provided. Applied to brand header graphics mounting panel. MOQ 10 units

**(Option DCOL2) Alternative Colour**  
Alternative ral colour to black (Ral 9005)

**(Option DGDRS2W) Front Lift-Up Glass Doors**  
Hinged glass (6mm) lift up doors (set of 2) 4 no.

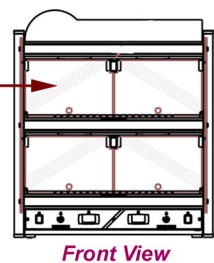

Front View